



CCTV Quick Guide

SV-4C-2DB4MX

Manual

Guía rápida
Kurzanleitung
Guida veloce
Guide rapide

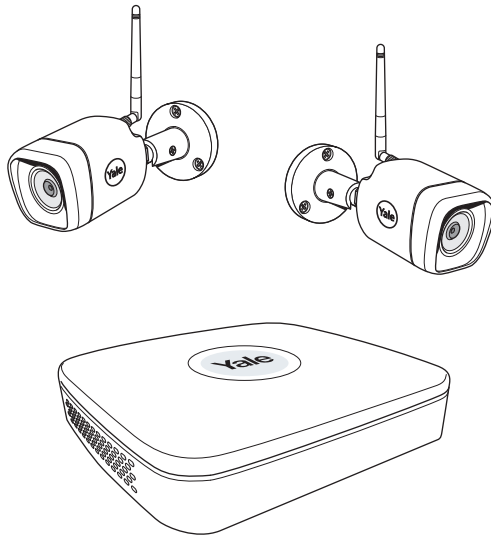



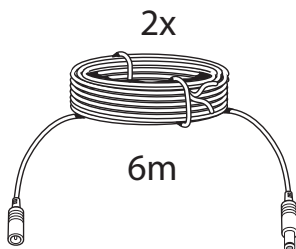
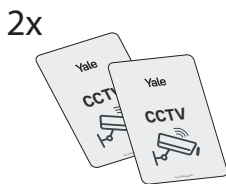
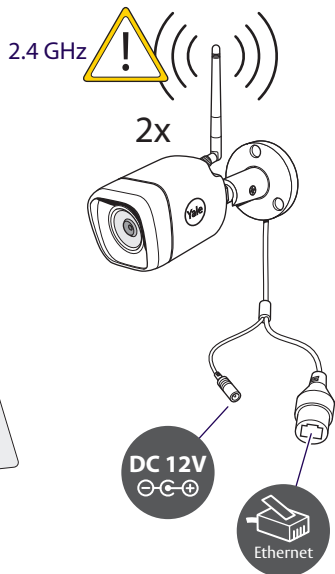
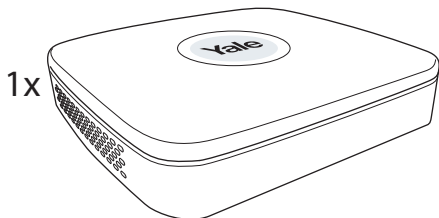



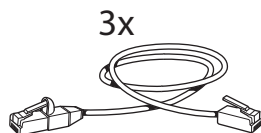
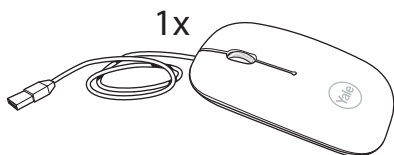
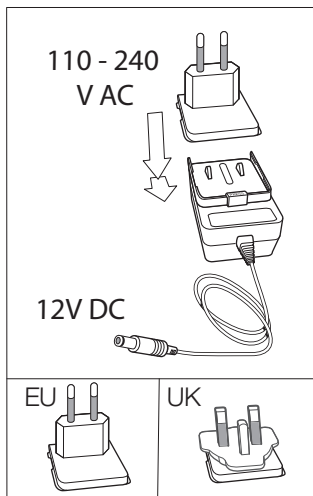





Part of ASSA ABLOY



3x



	HDD		
			
	Power		OFF
			ON
	Network		
			

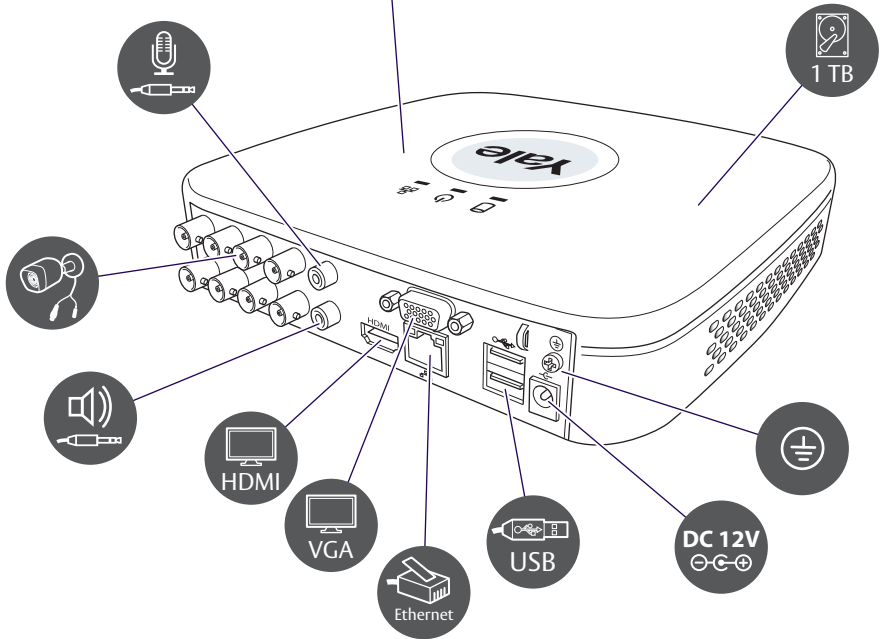

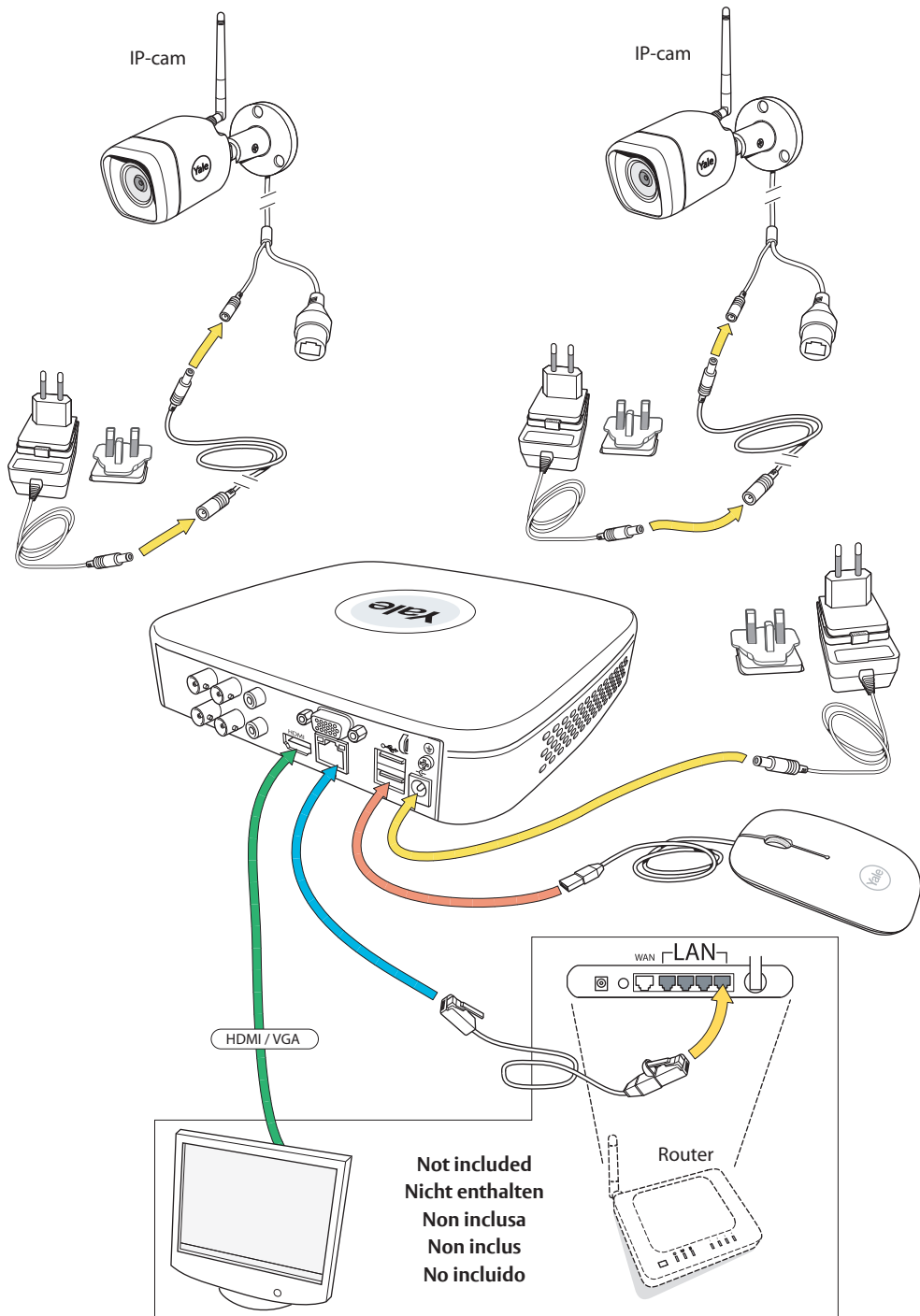

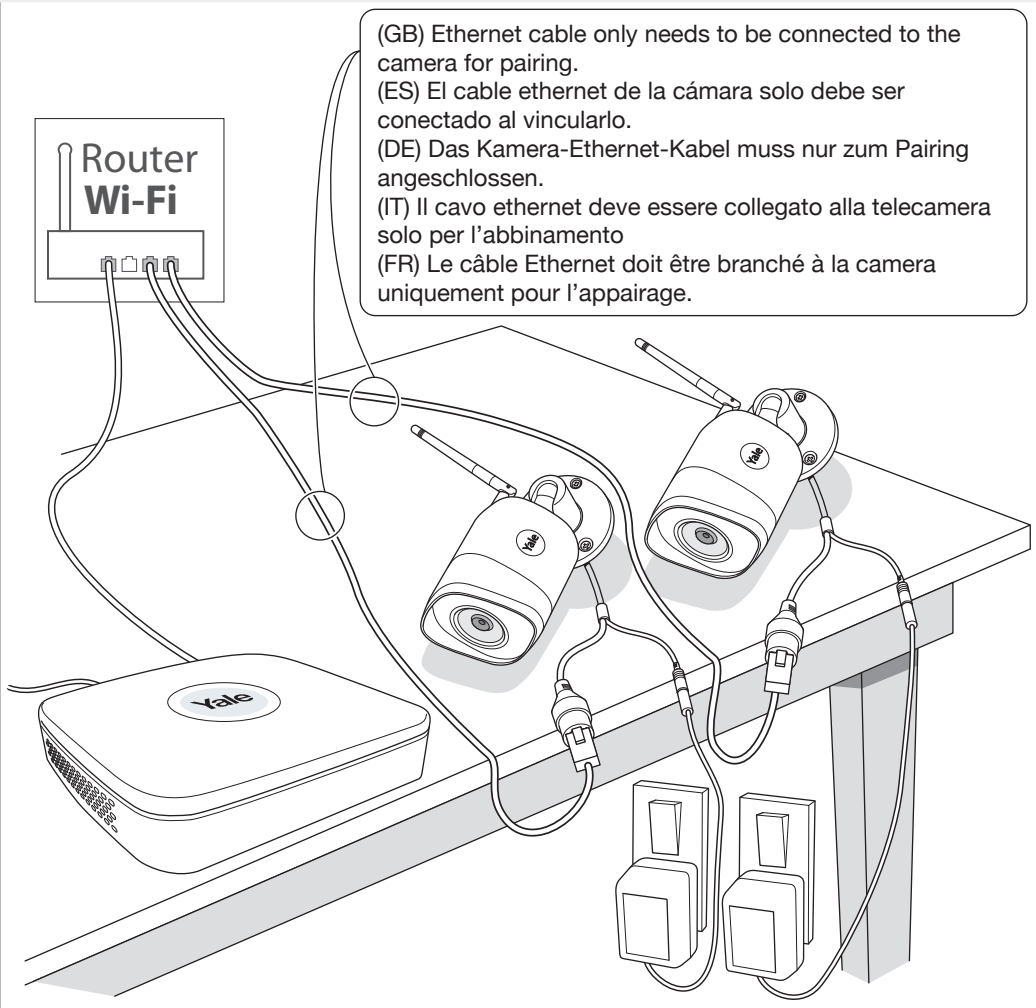

(GB) Ethernet cable only needs to be connected to the camera for pairing.
 (ES) El cable ethernet de la cámara solo debe ser conectado al vincularlo.
 (DE) Das Kamera-Ethernet-Kabel muss nur zum Pairing angeschlossen.
 (IT) Il cavo ethernet deve essere collegato alla telecamera solo per l'abbinamento
 (FR) Le câble Ethernet doit être branché à la camera uniquement pour l'appairage.



Not included
 MAX 32GB
 mSATA
 Max 128GB

Nicht enthalten
 Non inclusa
 Non inclus
 No incluido

Press 10 sec
 Reset
 Reiniciar
 Zurücksetzen
 Réinitialiser

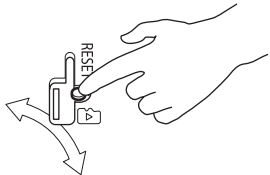

Press 1 sec
 WPS
 (Wi-Fi Protected Setup)

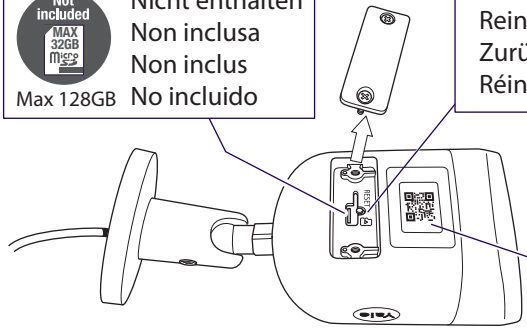

Yale View 



(GB) Create an account - (ES) Crear una cuenta - (DE) Benutzerkonto anlegen
(IT) Creare un profilo - (FR) Créer un compte



a



Email Register

b



Email verification

116s

c



Create a Password



(GB) Create an account - (ES) Crear una cuenta - (DE) Benutzerkonto anlegen
(IT) Creare un profilo - (FR) Créer un compte

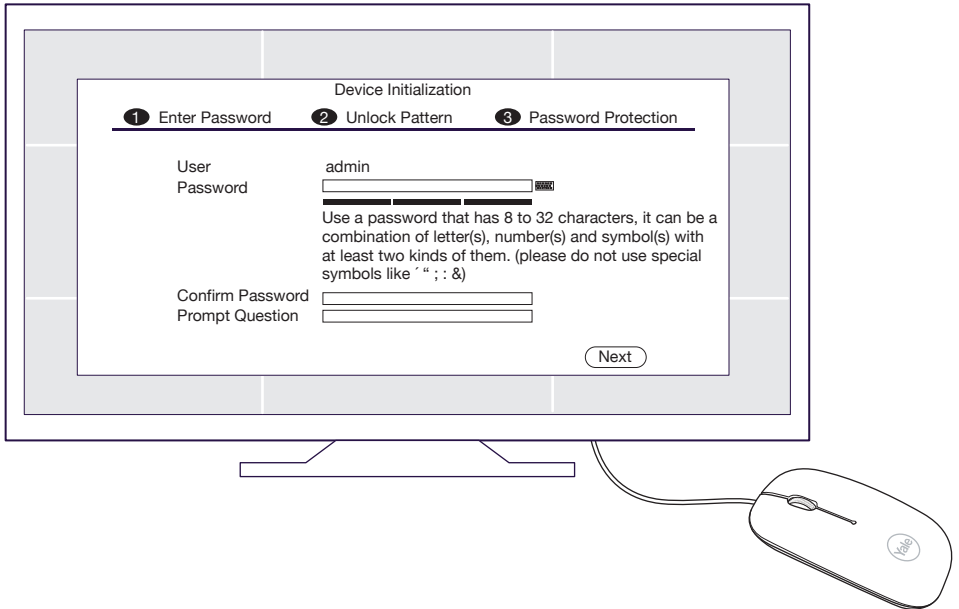

(GB) Follow on-screen instructions
(DE) Der Schritt für Schritt Anleitung auf dem Bildschirm folgen
(ES) Seguir paso a paso el proceso de configuración que aparece en pantalla
(IT) Seguire l' impostazione sullo schermo passo dopo passo
(FR) Suivre pas à pas les instructions d'installation à l'écran

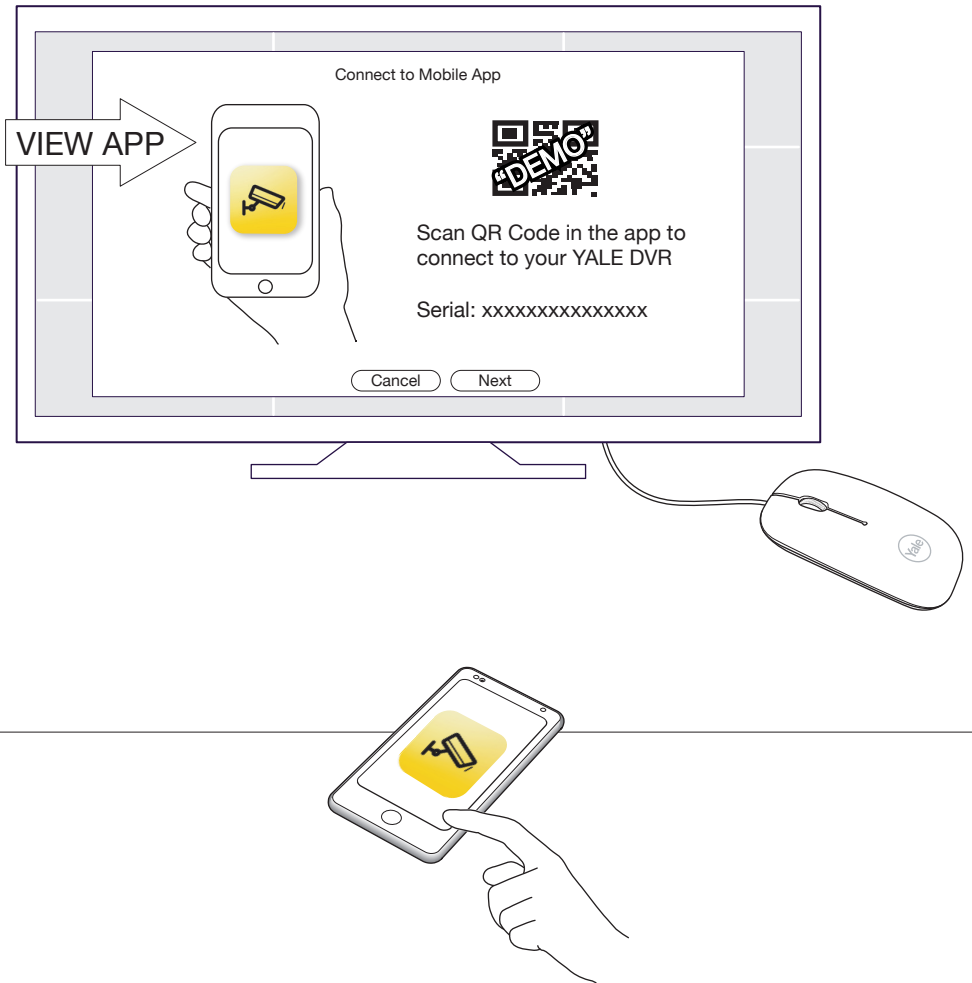

- (GB) Follow on-screen instructions
(DE) Der Schritt für Schritt Anleitung auf dem Bildschirm folgen
(ES) Seguir paso a paso el proceso de configuración que aparece en pantalla
(IT) Seguire l' impostazione sullo schermo passo dopo passo
(FR) Suivre pas à pas les instructions d'installation à l'écran

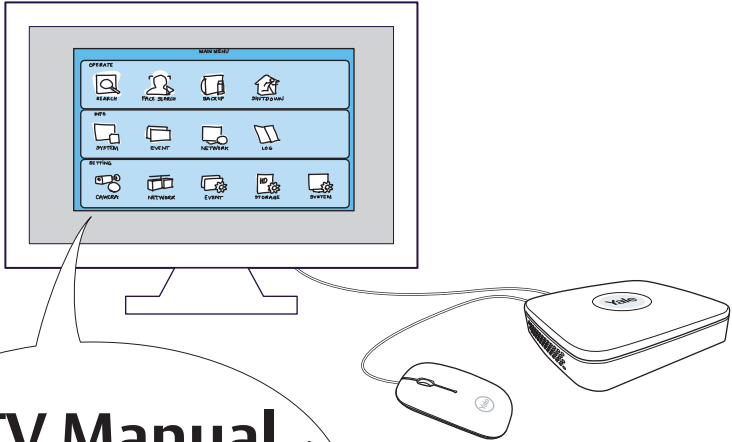

CCTV Manual

Manual de usuario
Bedienungsanleitung
Manuale
Manuel utilisateur



www.yalehome.com/manuals

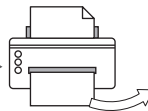

1

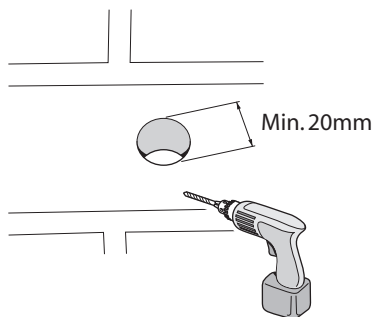

2

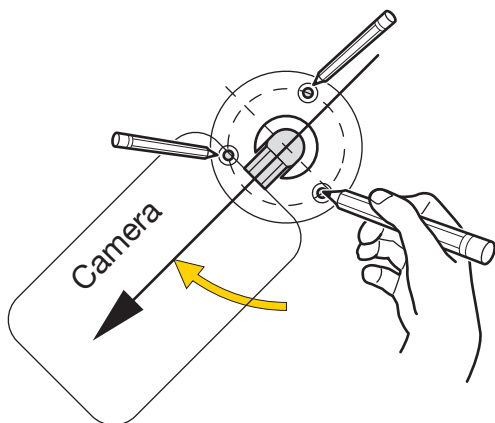

3

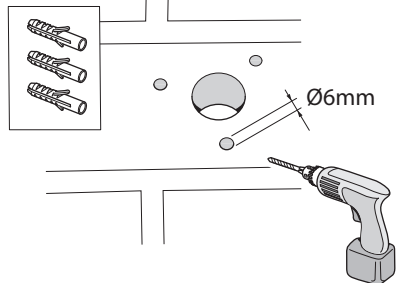

4

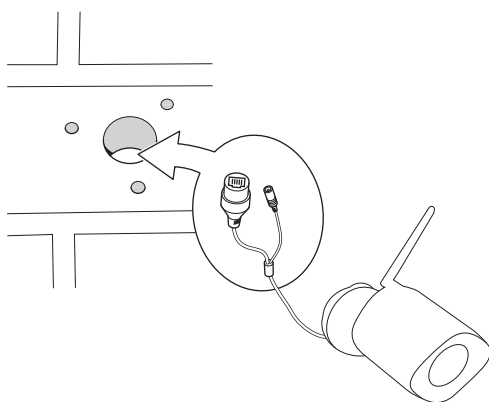

5

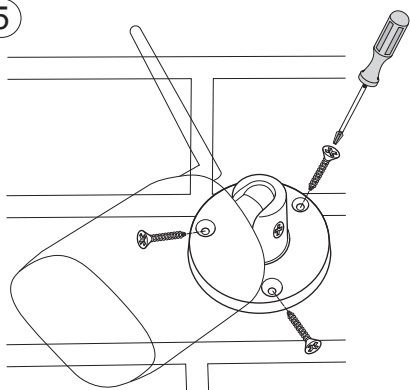

6

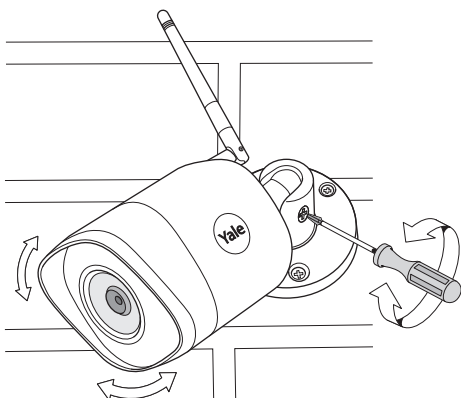

i**GB:**

Hereby, ASSA ABLOY Ltd., School Street, Willenhall, West Midlands, England Wv13 3PW declares that the radio equipment type SV-4C-2DB4MX is in compliance with Directive 2014/53/EU. The full text of the EU declaration of conformity is available at the following internet address: www.yalehome.com/smart-living/doc

FR:

Le soussigné, ASSA ABLOY Ltd., School Street, Willenhall, West Midlands, England Wv13 3PW, déclare que l'équipement radioélectrique du type SV-4C-2DB4MX est conforme à la directive 2014/53/UE. Le texte complet de la déclaration UE de conformité est disponible à l'adresse internet suivante: www.yalehome.com/smart-living/doc

••• Message à destination des professionnels •••

Si vous souhaitez installer SV-4C-2DB4MX dans votre société, vous devez obligatoirement demander une autorisation à la Commission Nationale de l'Informatique et des Libertés.

ES:

Por la presente, ASSA ABLOY Ltd., School Street, Willenhall, West Midlands, England Wv13 3PW declara que el tipo de equipo radioeléctrico SV-4C-2DB4MX es conforme con la Directiva 2014/53/UE. El texto completo de la declaración UE de conformidad está disponible en la dirección Internet siguiente: www.yalehome.com/smart-living/doc

DE:

Hiermit erklärt ASSA ABLOY Ltd., School Street, Willenhall, West Midlands, England Wv13 3PW, dass der Funkanlagentyp SV-4C-2DB4MX der Richtlinie 2014/53/UE entspricht. Der vollständige Text der EU-Konformitätserklärung ist unter der folgenden Internetadresse verfügbar: www.yalehome.com/smart-living/doc

IT:

Il fabbricante, ASSA ABLOY Ltd., School Street, Willenhall, West Midlands, England Wv13 3PW, dichiara che il tipo di apparecchiatura radio SV-4C-2DB4MX è conforme alla direttiva 2014/53/UE. Il testo completo della dichiarazione di conformità UE è disponibile al seguente indirizzo Internet: 22.5.2014 L 153/104 Gazzetta ufficiale dell'Unione europea IT: www.yalehome.com/smart-living/doc

The power shall conform to the requirement in the SELV (Safety Extra Low Voltage) and the Limited power source is rated DC 12V in the IEC60950-1. (Power supply requirement is subject to the device label). Manufacturers: Shenzhen HONOR Electronic Co., Ltd.



Model: ADS-26SGP-12 12024E

Input: 100-240V~, 50/60Hz, max. 0.7A

Output: DC 12V; 2.0A

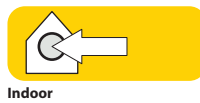
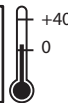
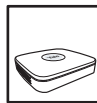

Indoor

Frequency / Band	EIRP [dBm]
WiFi 2400MHz~2483.5MHz	10 - 15dBm

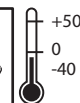
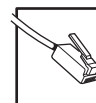
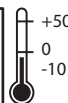

Less than
95% RH



Outdoor

Support



Manual



www.yalehome.com/doc
www.yalehome.com/manuals



ASSA ABLOY Opening Solutions Poland S.A.,
Ul. Magazynowa 4, 64-100 Leszno, Poland
UK: ASSA ABLOY Ltd., School Street, Willenhall,
West Midlands, England Wv13 3PW



THE YALE BRAND, with its unparalleled global reach and range of products, reassures more people in more countries than any other consumer locking solution.

THE ASSA ABLOY GROUP is the world's leading manufacturer and supplier of locking solutions, dedicated to satisfying end-user needs for security, safety and convenience.

Part of ASSA ABLOY