

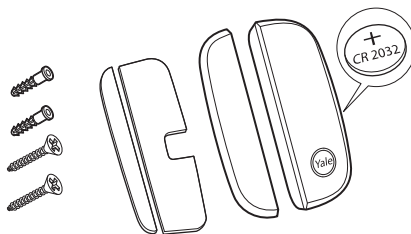

Product Code: **AC-DC**



**(GB)** Please see your Yale Sync Smart Home Alarm system Instruction manual for the following: Adding this component to your Alarm, Installing, Changing the batteries, Troubleshooting. To download the manual please visit the product page at [www.yalelock.com/smart-living](http://www.yalelock.com/smart-living)

**(DE)** In der Bedienungsanleitung Deines Yale Sync Smart Home Alarms findest Du weitere Informationen zu: Einbinden dieses Zubehörs in Dein Alarmsystem, Einlegen und Wechseln der Batterien und Fehlersuche. Das Handbuch kannst Du herunterladen auf [www.yalelock.com/smart-living](http://www.yalelock.com/smart-living)

**(FR)** Veuillez consulter le mode d'emploi de votre système d'alarme Yale Sync pour les opérations suivantes : ajout d'un nouvel appareil, installation, remplacement des piles, dépannage. Pour télécharger le manuel d'utilisation complet, visitez [www.yalelock.com/smart-living](http://www.yalelock.com/smart-living)

**(IT)** Si prega di consultare il manuale istruzioni dell'allarme Yale Sync Smart Home per le seguenti operazioni: Aggiungere questo componente al vostro Allarme, Installazione, Sostituzione batterie, Risoluzione dei problemi. Per scaricare il manuale visita la pagina prodotto [www.yalelock.com/smart-living](http://www.yalelock.com/smart-living)

**(ES)** Por favor, consultar el manual de instrucciones de Yale Sync Smart Home Alarm para lo siguiente: Añadir este dispositivo a tu alarma, instalación, cambio de pilas y preguntas frecuentes. Para la descarga del manual puedes visitar [www.yalelock.com/smart-living](http://www.yalelock.com/smart-living)

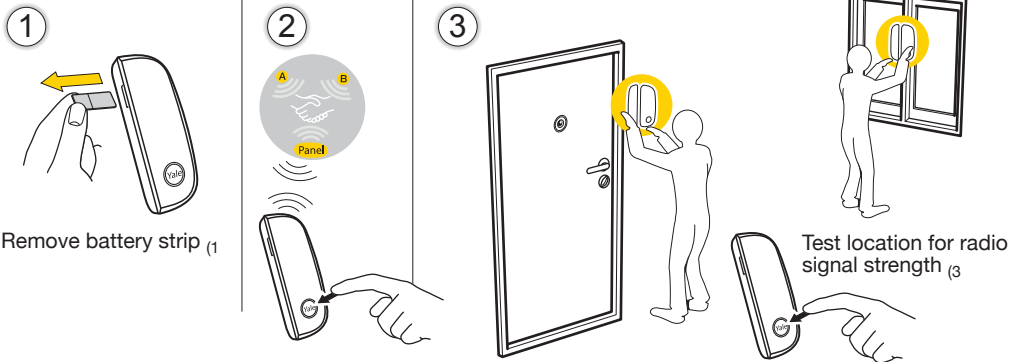

(1) (DE) Entfernen der Batteriefolie - (FR) Retirez la languette de protection des piles -  
(IT) Rimuovi la linguetta della batteria - (ES) Retira la tira de la batería

(2) (DE) Verbinden - (FR) Apparez - (IT) Associazione - (ES) Vincular.

(3) (DE) Teste die Signalstärke am geplanten Standort - (FR) Testez la portée du signal dans les emplacements envisagés - (IT) Verifica la potenza del segnale nella posizione prescelta -  
(ES) Comprueba la ubicación para una correcta señal de radio.



1

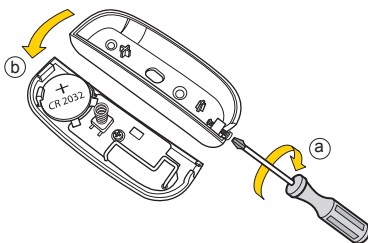
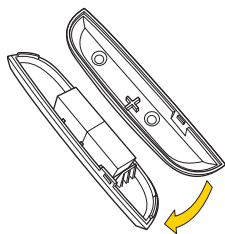

2 a

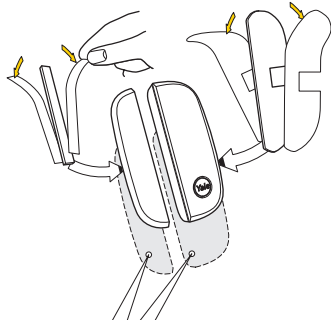

2 b

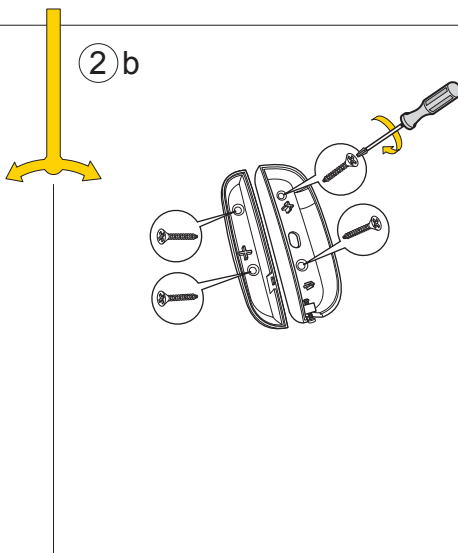

i



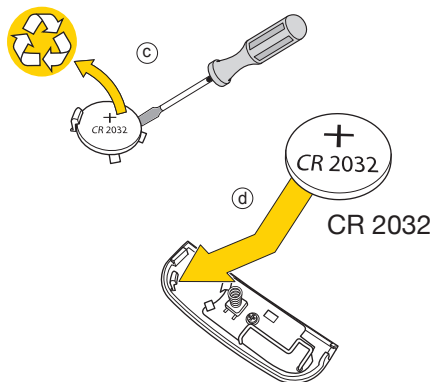
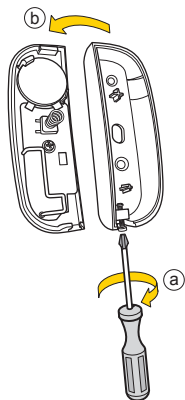
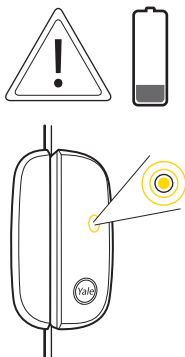

**i**

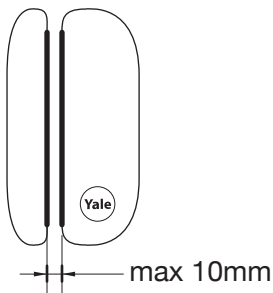
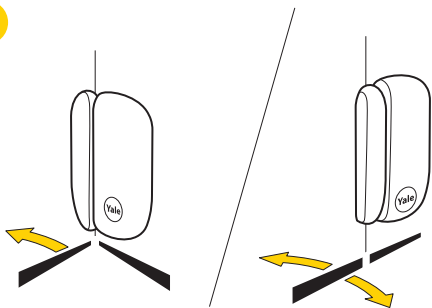

(GB) Environment - (DE) Umgebung - (FR) Environnement - (IT) Ambiente - (ES) Ambiente.

**Specification**



Housings ABS/polycarbonate  
Radio: 868 MHz FM  
RF Transmission: 18mA

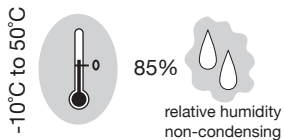

Product	Frequency / Band	EIRP [dBm]
AC-DC	F1-868-2W	-0.7±3dB

(DE) Alle Geräte , Gehäuse ABS Polycarbonat.  
(FR) Tous les dispositifs. Caissons ABS / polycarbonate.  
(IT) Involucro di TUTTI i dispositivi ABS/polycarbonato.  
(ES) Todos los dispositivos. Carcasas de ABS / polycarbonato.



**(GB)** Hereby, ASSA ABLOY Ltd., School Street, Willenhall, West Midlands, England WV13 3PW declares that the radio equipment type AC-DC is in compliance with Directive 2014/53/EU. The full text of the EU declaration of conformity is available at the following internet address:

[www.yalelock.com/smart-living/doc](http://www.yalelock.com/smart-living/doc)

**(DE)** Hiermit erklärt ASSA ABLOY Ltd., School Street, Willenhall, West Midlands, England WV13 3PW, dass der Funkanlagentyp AC-DC der Richtlinie 2014/53/EU entspricht. Der vollständige Text der EU-Konformitätserklärung ist unter der folgenden Internetadresse verfügbar:

[www.yalelock.com/smart-living/doc](http://www.yalelock.com/smart-living/doc)

**(FR)** Le soussigné, ASSA ABLOY Ltd., School Street, Willenhall, West Midlands, England WV13 3PW, déclare que l'équipement radioélectrique du type AC-DC est conforme à la directive 2014/53/UE. Le texte complet de la déclaration UE de conformité est disponible à l'adresse internet suivante: [www.yalelock.com/smart-living/doc](http://www.yalelock.com/smart-living/doc) ••• Message à destination des professionnels ••• Si vous souhaitez installer Smart Home/ phone Alarm dans votre société, vous devez obligatoirement demander une autorisation à la Commission Nationale de l'Informatique et des Libertés.

**(IT)** Il produttore, ASSA ABLOY Ltd., School Street, Willenhall, West Midlands, England WV13 3PW, dichiara che il tipo di apparecchiatura radio AC-DC è conforme alla direttiva 2014/53/UE. Il testo completo della dichiarazione di conformità UE è disponibile al seguente indirizzo Internet: 22.5.2014 L 153/104 Gazzetta ufficiale dell'Unione europea IT: [www.yalelock.com/smart-living/doc](http://www.yalelock.com/smart-living/doc)

**(ES)** Por la presente, ASSA ABLOY Ltd., School Street, Willenhall, West Midlands, England WV13 3PW declara que el tipo de equipo radioeléctrico AC-DC es conforme con la Directiva 2014/53/UE. El texto completo de la declaración UE de conformidad está disponible en la dirección Internet siguiente: [www.yalelock.com/smart-living/doc](http://www.yalelock.com/smart-living/doc)



**THE YALE BRAND**, with its unparalleled global reach and range of products, reassures more people in more countries than any other consumer locking solution.

**THE ASSA ABLOY GROUP** is the world's leading manufacturer and supplier of locking solutions, dedicated to satisfying end-user needs for security, safety and convenience.

An ASSA ABLOY Group brand

**ASSA ABLOY**